

CLASS 45XX LOCOMOTIVE

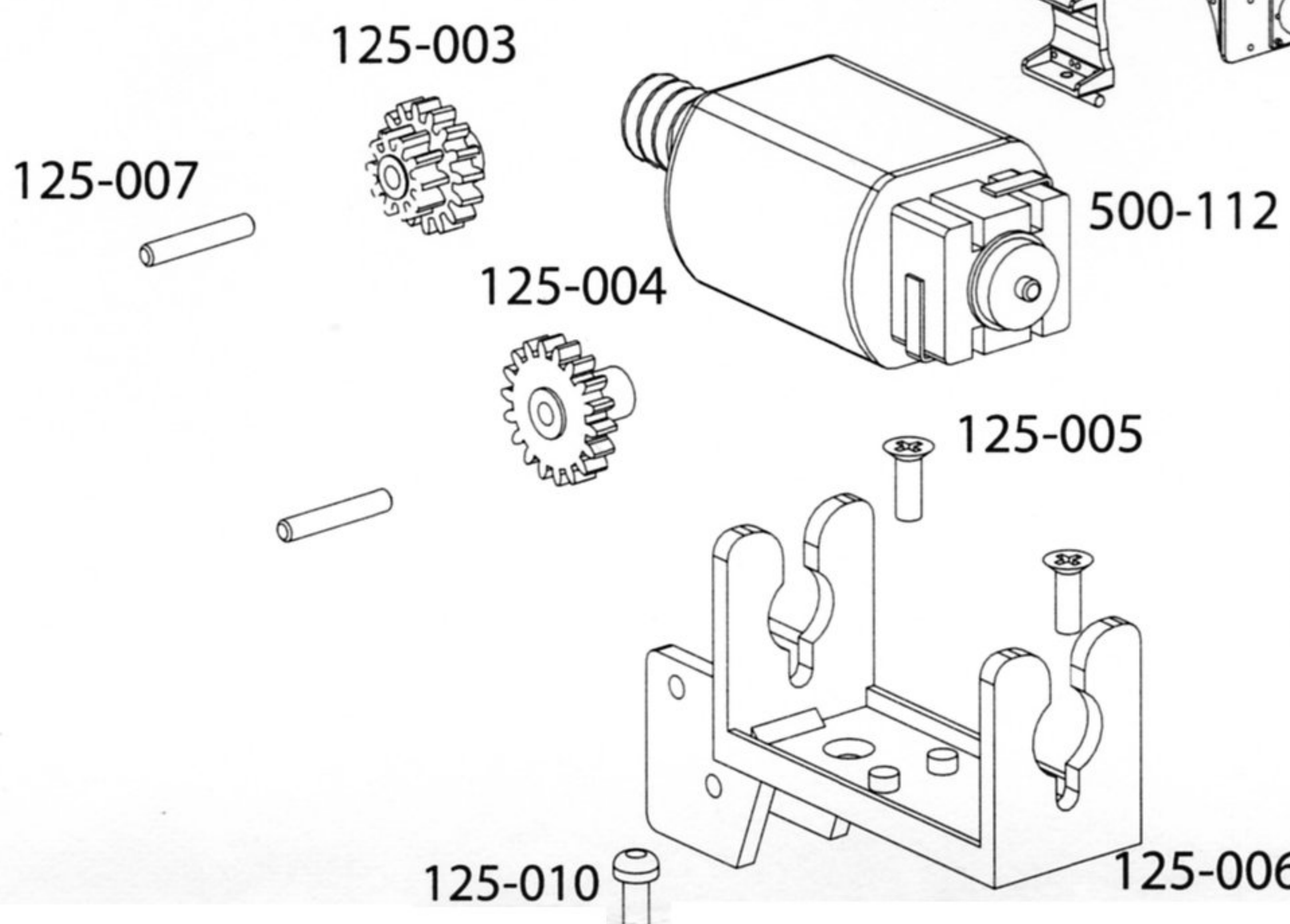

IMPORTANT!
 WHEN ORDERING ANY REPLACEMENT PARTS PLEASE ENSURE TO QUOTE THE APPROPRIATE CATALOGUE NUMBER/LIVERY OF YOUR BACHMANN LOCOMOTIVE. IN ADDITION TO THE NUMBER OF THE PART REQUIRED.

PLEASE NOTE WE WOULD LIKE TO BRING YOUR ATTENTION TO RUNNING - IN WHICH IS NECESSARY WITH THIS TYPE OF DRIVE. RUN FOR APPROXIMATELY ONE HOUR TO ALLOW WORKING PARTS TO BED - IN. LIGHTLY OIL THE MOTOR BEARINGS AND GEARS WHEN REQUIRED.

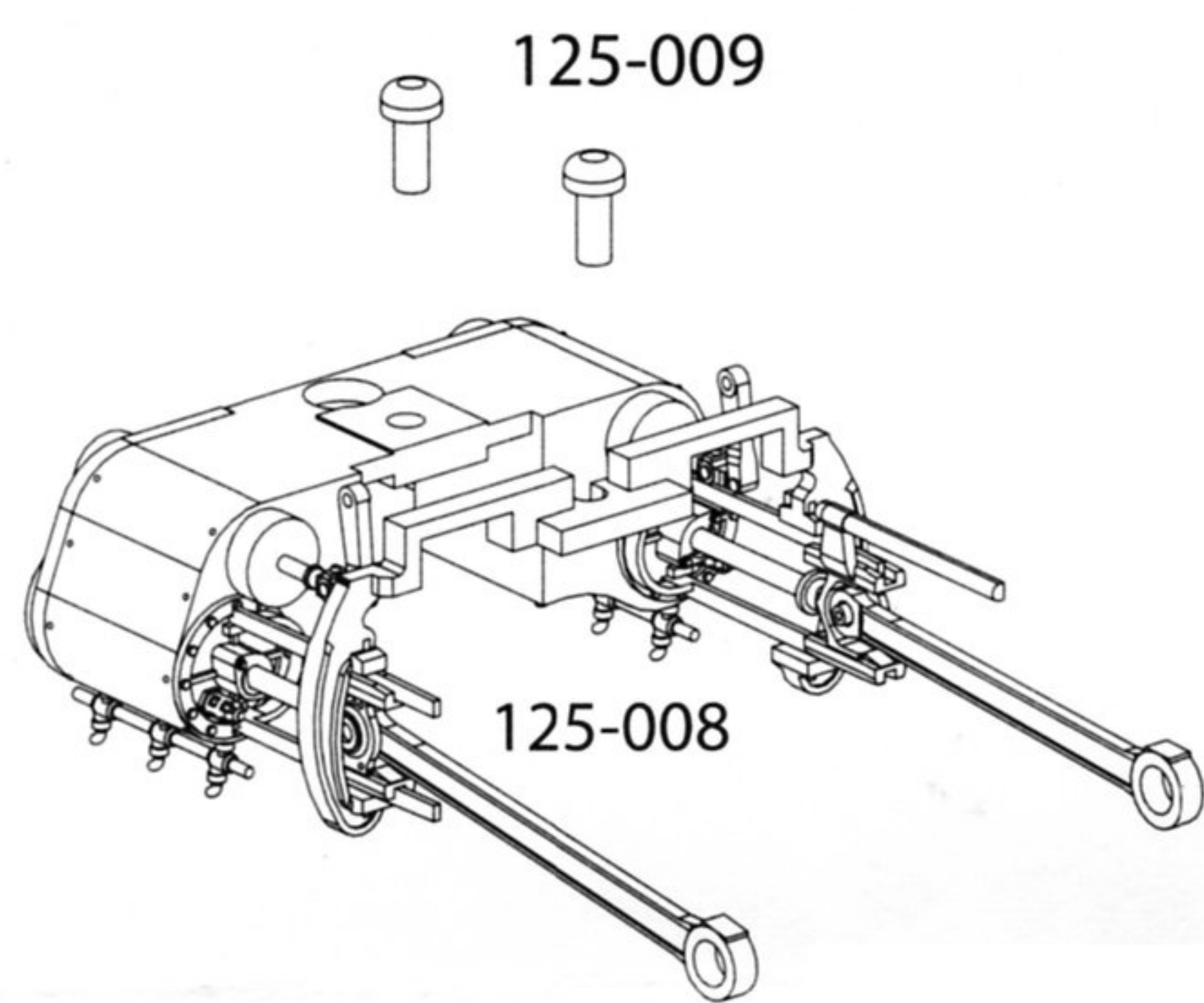
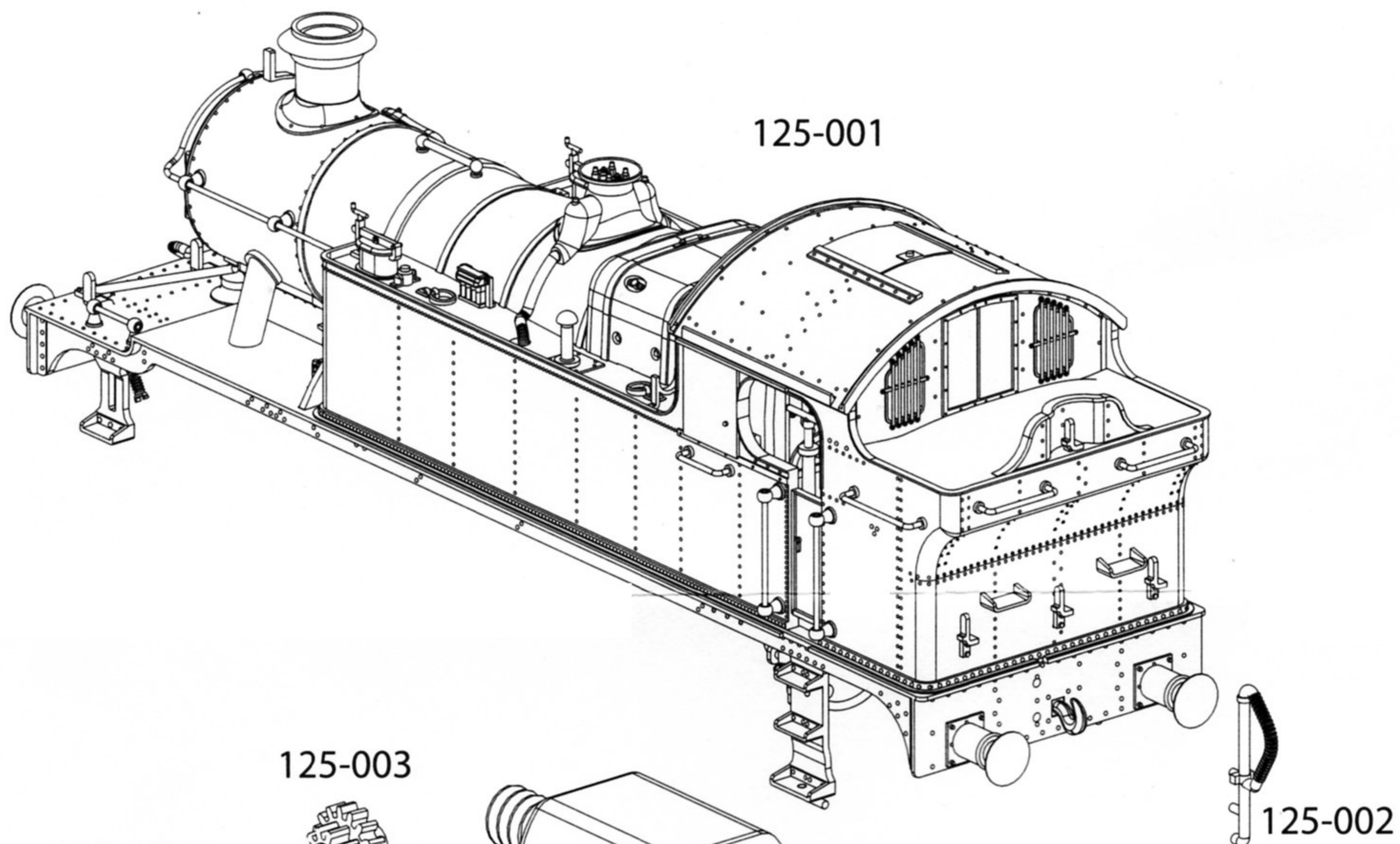